

Varenummer: 3901044010700
 Beskrivelse: Snekkegear med fri indgangsaksel
 VF 44P-10-HS

Mål

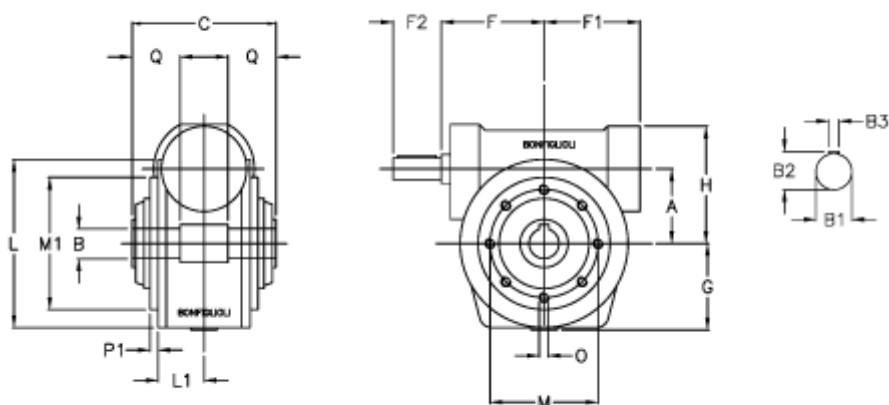

a	= 44.6	F1	= 54	O	= M6x8
B	= 18	F2	= 30	P1	= 2.0
B1	= 11	g	= 51	Q	= 24.5
B2	= 12.5	H	= 71		
B3	= 4	L	= 80.0		
Betegnelse	= VF 44P-xx-HS	L1	= 35.0		
C	= 64	m	= 65		
F	= 54.0	M1	= 50		